

TAIGA



Your
natural
workspace

Taiga Product Datasheets

Lohko Box¹

Product number: LB01V3
Ventilation: 60 l/s
Capacity: 1 person
Size: W 1100 mm L 1100 mm H 2200 mm



Lohko Box²

Product number: LB02V3
Ventilation: 70 l/s
Capacity: 2 people
Size: W 2400 mm L 1200 mm H 2200 mm



Lohko Box³

Product number: LB03V3
Ventilation: 70 l/s
Capacity: 4 people
Size: W 2400 mm L 1600 mm H 2200 mm



Lohko Box⁵

Product number: LB05V3
Ventilation: 140 l/s
Capacity: 5 people
Size: W 2400 mm L 2400 mm H 2200 mm



Lohko Box⁷

Product number: LB07V3
Ventilation: 140 l/s
Capacity: 6 people
Size: W 2400 mm L 3200 mm H 2200 mm



Lohko Picea³

Product number: LP1818
Ventilation: 70 l/s
Capacity: 2 people
Size: W 1800 mm L 1800 mm H 2200 mm



1 m² ... 7 m²
**Lohko
Box**

3 m²
**Lohko
Picea**

Lohko Flex¹⁰

Product number: LF363000
Ventilation: 210 l/s
Capacity: 8 people
Size: W 3600 mm L 3000 mm H 2400 mm



Lohko Flex¹²

Product number: LF363600
Ventilation: 210 l/s
Capacity: 10 people
Size: W 3600 mm L 3600 mm H 2400 mm



Lohko Flex¹⁴

Product number: LF364200
Ventilation: 280 l/s
Capacity: 12 people
Size: W 3600 mm L 4200 mm H 2400 mm



Lohko Flex²¹

Product number: LF544200
Ventilation: 280 l/s
Capacity: 14 people
Size: W 5400 mm L 4200 mm H 2400 mm



Lohko Flex²⁵

Product number: LF544800
Ventilation: 280 l/s
Capacity: 16 people
Size: W 5400 mm L 4800 mm H 2400 mm



Lohko Flex²⁸

Product number: LF545400
Ventilation: 350 l/s
Capacity: 18 people
Size: W 5400 mm L 5400 mm H 2400 mm



10 m² ... 28 m²
**Lohko
Flex**



GENERAL DESCRIPTION

Product number	LB01V3
Capacity	1 person
Ventilation	60 l/s

MATERIALS

Surface	Veneer or laminate
Walls structure	Wooden sandwich structure
Textile Carpet	85% polyamide / 15% polypropylene
Glass	Laminated and tempered sound control glass
Acoustic panels	2 pcs, fabric 98% post-consumer recycled polyester / 2% polyester
Table	Antibacterial black matt laminate

MEASUREMENTS

External dimensions	W. 1100 mm L. 1100 mm H. 2250 mm
Wall dimensions	W. 1100 mm L. 1100 mm H. 2200 mm
Internal dimensions	W. 980 mm L. 1020 mm H. 2110 mm
Recommended ceiling height	H. 2350 mm
Door opening width	W. 930 mm H. 2100 mm
Product weight	approx. 310 kg
Product package	W. 1200 mm L. 2250 mm H. 590 mm
Packed weight	approx. 375 kg

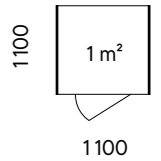

POWER

	EU / UK / CHINA	US
Input	220-240 VAC / 10 A	100-130 VAC / 15 A
Output	220-240 VAC / 9 A	100-130 VAC / 14 A
Frequency	50/60 Hz	50/60 Hz
Normal power consumption	23,8 W	23,8 W
Max. power consumption	28,8 W	28,8 W
LED power consumption	7,8 W	7,8 W
Normal Fan power consumption	16 W	16 W
Standby Fan power consumption	11 W	11 W
Max. Fan power consumption	21 W	21 W

Power supply	From roof or from floor with 5 m power cable
Socket	1 pc power socket
Light	1 x Dimmable LED light, Length 0,6m, Lumens 984 lm, color temperature 4000 k
Ventilation	Adjustable fan, Auto mode
Safety Switch	RCBO

WARRANTY

Elements / glass	5 years
Electric	2 years

SPRINKLER / CABLE HOLE

Safe modification area for small holes marked on roof.
See instructions before any modifications!

DOOR HANDEDNESS

Left or right handed option

EXTRA ACCESSORIES

Clothes hook	
LBP Stool	
Extra sockets (power, USB, RJ45 CAT6)	

COLOR OPTIONS

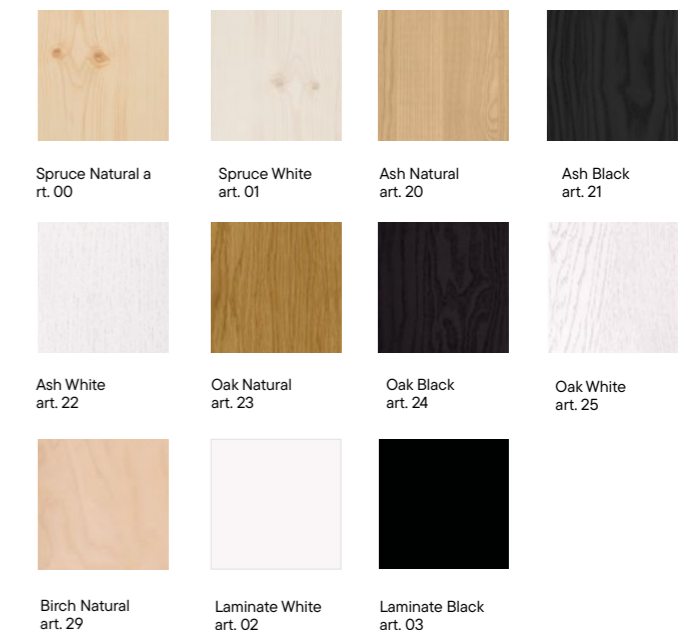

Custom

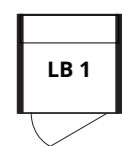

Focus

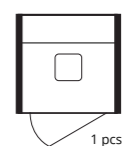

1 pcs LB Stool

Focus

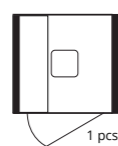

1 pcs LB Stool

Lohko Box¹

Soundproof office phone booth for private phone calls and remote meetings. A convenient way to reduce distractions and bring harmony to a noisy office.





GENERAL DESCRIPTION

Product number	LB02V3
Capacity	1-2 people
Ventilation	70 l/s

MATERIALS

Surface	Veneer or laminate
Walls structure	Wooden sandwich structure
Textile Carpet	85% polyamide / 15% polypropylene
Glass	Laminated and tempered sound control glass
Acoustic panels	2 pcs, fabric 98% post-consumer recycled polyester / 2% polyester

MEASUREMENTS

External dimensions	W. 2400 mm L. 1200 mm H. 2250 mm
Wall dimensions	W. 2400 mm L. 1200 mm H. 2200 mm
Internal dimensions	W. 2280 mm L. 1120 mm H. 2110 mm *
Recommended ceiling height	H. 2400 mm
Door opening width	W. 850 mm H. 2100 mm
Product weight	approx. 530 kg
Product packages	1 pallet W. 750 mm L. 2500 mm H. 1160 mm 1 carton W. 1390 mm L. 1090 mm H. 110 mm
Packed weight	approx. 600 kg

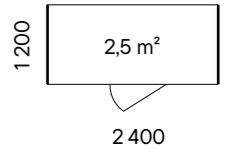

* 60mm less length near door frame

POWER

	EU / UK / CHINA	US
Input	220-240 VAC / 10 A	100-130 VAC / 15 A
Output	220-240 VAC / 9 A	100-130 VAC / 14 A
Frequency	50/60 Hz	50/60 Hz
Normal power consumption	42 W	42 W
Max. power consumption	47 W	47 W
LED power consumption	26 W	26 W
Normal Fan power consumption	16 W	16 W
Standby Fan power consumption	11 W	11 W
Max. Fan power consumption	21 W	21 W

Power supply	From roof or from floor with 5m power cable
Socket	1 x 4 pc power sockets
Light	1 x Dimmable LED light, Length 2 m, Lumens 3280 lm, color temperature 4000 k
Ventilation	Adjustable fan, Auto mode
Safety Switch	RCBO

Custom

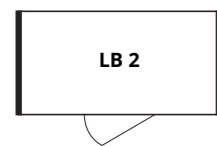

Collaborate

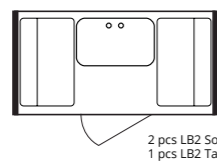

2 pcs LB2 Sofa
1 pcs LB2 Table

Focus

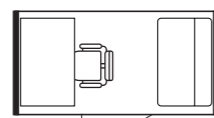

1 pcs 600mm Table *
1 pcs Chair *
1 pcs LB2 Sofa

WARRANTY

Elements / glass	5 years
Electric	2 years

SPRINKLER / CABLE HOLE

Safe modification area for small holes marked on roof.
See instructions before any modifications!

DOOR HANDEDNESS

Left or right handed option

EXTRA ACCESSORIES

- Clothes hook
- LB2 Table
- LB2 Sofa
- Screen Holder
- Extra sockets (power, USB, RJ45 CAT6)

COLOR OPTIONS

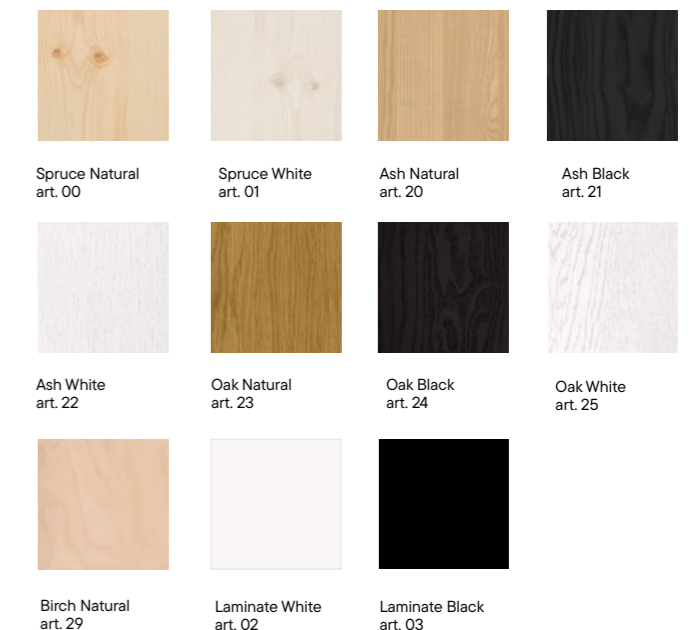

Lohko Box²

Private office pod for one, or a small meeting booth for two. Get your best work done in an enjoyable and distraction-free, environment.





GENERAL DESCRIPTION

Product number	LB03V3
Capacity	1-4 people
Ventilation	70 l/s

MATERIALS

Surface	Veneer or laminate
Walls structure	Wooden sandwich structure
Textile Carpet	85% polyamide / 15% polypropylene
Glass	Laminated and tempered sound control glass
Acoustic panels	2 pcs, fabric 98% post-consumer recycled polyester / 2% polyester

MEASUREMENTS

External dimensions	W. 2400 mm L. 1600 mm H. 2250 mm
Wall dimensions	W. 2400 mm L. 1600 mm H. 2200 mm
Internal dimensions	W. 2280 mm L. 1520 mm H. 2110 mm *
Recommended ceiling height	H. 2400 mm
Door opening width	W. 850 mm H. 2100 mm
Product weight	approx. 610 kg
Product packages	1 pallet W. 750 mm L. 2500 mm H. 1160 mm 1 carton W. 1390 mm L. 1090 mm H. 110 mm
Packed weight	approx. 680 kg

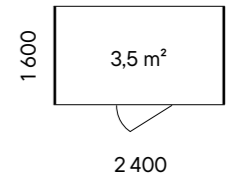

* 60mm less length near door frame

POWER

	EU / UK / CHINA	US
Input	220-240 VAC / 10 A	100-130 VAC / 15 A
Output	220-240 VAC / 9 A	100-130 VAC / 14 A
Frequency	50/60 Hz	50/60 Hz
Normal power consumption	42 W	42 W
Max. power consumption	47 W	47 W
LED power consumption	26 W	26 W
Normal Fan power consumption	16 W	16 W
Standby Fan power consumption	11 W	11 W
Max. Fan power consumption	21 W	21 W

Power supply	From roof or from floor with 5m power cable
Socket	1 x 4 pc power sockets
Light	1 x Dimmable LED light, Length 2 m, Lumens 3280 lm, color temperature 4000 k
Ventilation	Adjustable fan, Auto mode
Safety Switch	RCBO

Custom

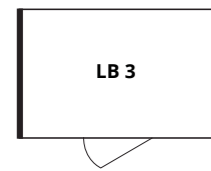

Collaborate

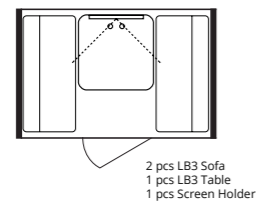

Focus

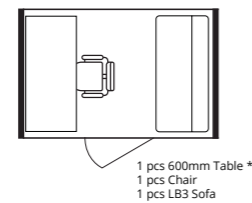

Focus

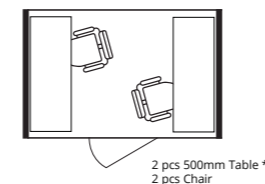

Lohko Box³

Optimal office pod or a meeting booth for 1 to 4 people. Versatile space that can be set up as a spacious workstation for one or a collaborative co-working area.



WARRANTY

Elements / glass	5 years
Electric	2 years

SPRINKLER / CABLE HOLE

Safe modification area for small holes marked on roof. See instructions before any modifications!

DOOR HANDEDNESS

Left or right handed option

EXTRA ACCESSORIES

- Clothes hook
- LB3 Table
- LB3 Sofa
- Screen Holder
- Extra sockets (power, USB, RJ45 CAT6)

COLOR OPTIONS

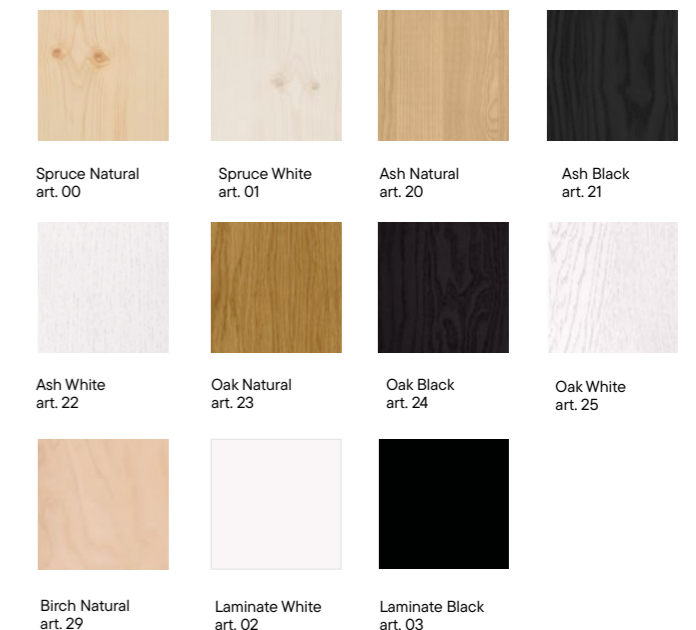



GENERAL DESCRIPTION

Product number	LB05V3
Capacity	1-5 people
Ventilation	140 l/s

MATERIALS

Surface	Veneer or laminate
Walls structure	Wooden sandwich structure
Textile Carpet	85% polyamide / 15% polypropylene
Glass	Laminated and tempered sound control glass
Acoustic panels	4 pcs, fabric 98% post-consumer recycled polyester / 2% polyester

MEASUREMENTS

External dimensions	W. 2400 mm L. 2400 mm H. 2250 mm
Wall dimensions	W. 2400 mm L. 2400 mm H. 2200 mm
Internal dimensions	W. 2280 mm L. 2320 mm H. 2110 mm *
Recommended ceiling height	H. 2450 mm
Door opening width	W. 850 mm H. 2100 mm
Product weight	approx. 795 kg
Product packages	2 pallets W. 750 mm L. 2500 mm H. 1160 mm 2 cartons W. 1390 mm L. 1090 mm H. 110 mm
Packed weight	approx. 935 kg

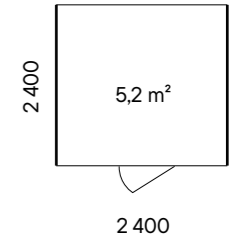

* 60mm less length near door frame

POWER

	EU / UK / CHINA	US
Input	220-240 VAC / 10 A	100-130 VAC / 15 A
Output	220-240 VAC / 9 A	100-130 VAC / 14 A
Frequency	50/60 Hz	50/60 Hz
Normal power consumption	84 W	84 W
Max. power consumption	94 W	94 W
LED power consumption	52 W	52 W
Normal Fan power consumption	32 W	32 W
Standby Fan power consumption	22 W	22 W
Max. Fan power consumption	42 W	42 W

Power supply	From roof or from floor with 5m power cable
Socket	1 x 4 pc power sockets
Light	2 x Dimmable LED light, Length 2 m, Lumens 6560 lm, color temperature 4000 K
Ventilation	Adjustable fan, Auto mode
Safety Switch	RCBO

WARRANTY

Elements / glass	5 years
Electric	2 years

SPRINKLER / CABLE HOLE

Safe modification area for small holes marked on roof.
See instructions before any modifications!

DOOR HANDEDNESS

Left or right handed option

EXTRA ACCESSORIES

Clothes hook
LB5 Table
Screen Holder
Extra sockets (power, USB, RJ45 CAT6)

COLOR OPTIONS

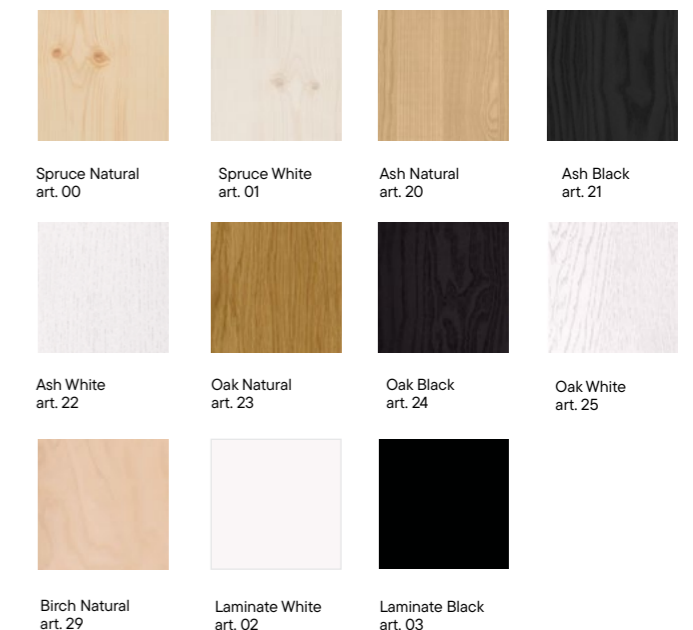

Custom

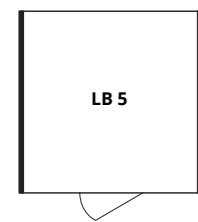

Collaborate

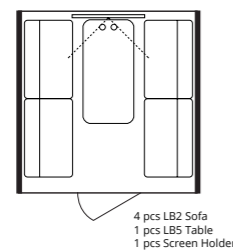

Relax

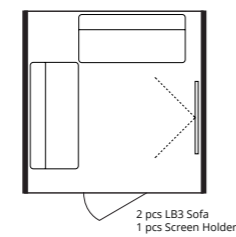

Meet

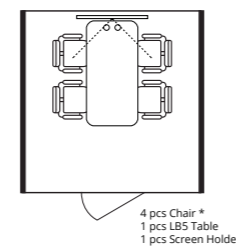

Focus

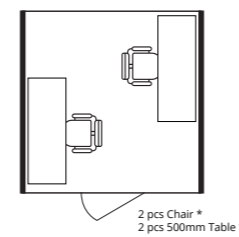

Lohko Box⁵

An ideal office meeting booth for up to 5 people. A harmonious setting for small teams to brainstorm and collaborate in a comfortable and serene environment.





GENERAL DESCRIPTION

Product number	LB07V3
Capacity	1-7 people
Ventilation	140 l/s

MATERIALS

Surface	Veneer or laminate
Walls structure	Wooden sandwich structure
Textile Carpet	85% polyamide / 15% polypropylene
Glass	Laminated and tempered sound control glass
Acoustic panels	4 pcs, fabric 98% post-consumer recycled polyester / 2% polyester

MEASUREMENTS

External dimensions	W. 2400 mm L. 3200 mm H. 2250 mm
Wall dimensions	W. 2400 mm L. 3200 mm H. 2200 mm
Internal dimensions	W. 2280 mm L. 3120 mm H. 2110 mm *
Recommended ceiling height	H. 2450 mm
Door opening width	W. 850 mm H. 2100 mm
Product weight	approx. 995 kg
Product packages	2 pallets W. 750 mm L. 2500 mm H. 1160 mm 2 cartons W. 1390 mm L. 1090 mm H. 110 mm
Packed weight	approx. 1145 kg

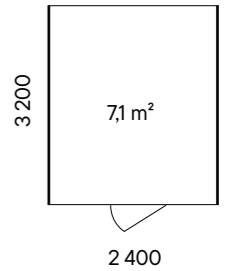

* 60mm less length near door frame

POWER

	EU / UK / CHINA	US
Input	220-240 VAC / 10 A	100-130 VAC / 15 A
Output	220-240 VAC / 9 A	100-130 VAC / 14 A
Frequency	50/60 Hz	50/60 Hz
Normal power consumption	84 W	84 W
Max. power consumption	94 W	94 W
LED power consumption	52 W	52 W
Normal Fan power consumption	32 W	32 W
Standby Fan power consumption	22 W	22 W
Max. Fan power consumption	42 W	42 W

Power supply	From roof or from floor with 5m power cable
Socket	1 x 4 pc power sockets
Light	2 x Dimmable LED light, Length 2 m, Lumens 6560 lm, color temperature 4000 K
Ventilation	Adjustable fan, Auto mode
Safety Switch	RCBO

WARRANTY

Elements / glass	5 years
Electric	2 years

SPRINKLER / CABLE HOLE

Safe modification area for small holes marked on roof.
See instructions before any modifications!

DOOR HANDEDNESS

Left or right handed option

EXTRA ACCESSORIES

- Clothes hook
- LB7 Table
- Screen Holder
- Extra sockets (power, USB, RJ45 CAT6)

COLOR OPTIONS

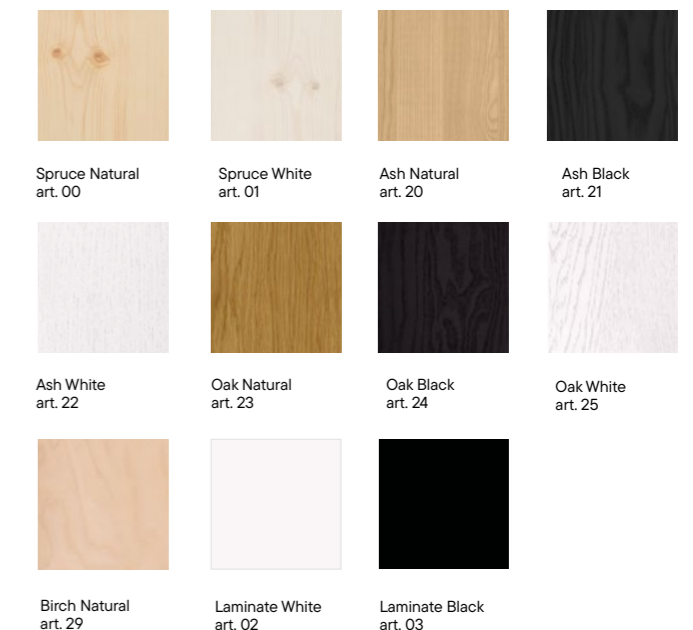

Custom

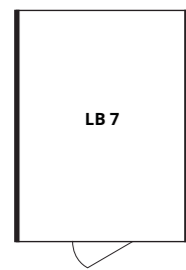

Collaborate

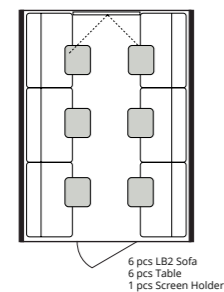

Relax

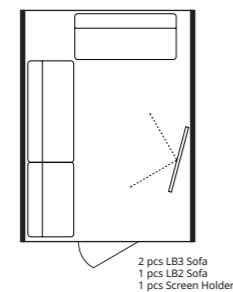

Meet

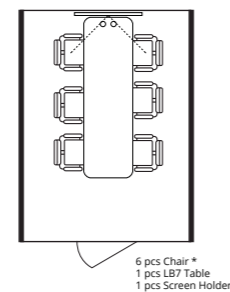

Focus

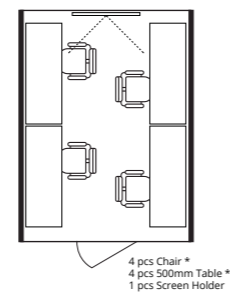

Lohko Box⁷

An efficient meeting pod or a coworking booth for up to 7 people. With ample room for tables and other accessories, it's an optimal office booth for collaboration.





GENERAL DESCRIPTION

Product number	LP1818
Capacity	1-2 people
Ventilation	70 l/s

MATERIALS

Surface	Veneer or laminate
Walls structure	Wooden sandwich structure
Textile Carpet	85% polyamide / 15% polypropylene
Glass	Laminated and tempered sound control glass
Acoustic panels	4 pcs, fabric 98% post-consumer recycled polyester / 2% polyester

MEASUREMENTS

External dimensions	W. 1800 mm L. 1800 mm H. 2280 mm
Wall dimensions	W. 1800 mm L. 1800 mm H. 2200 mm
Internal dimensions	W. 1630 mm L. 1730 mm H. 2110 mm *
Recommended ceiling height	H. 2400 mm
Door opening width	W. 850 mm H. 2100 mm
Product weight	approx. 570 kg
Product packages	1 pallet W. 750 mm L. 2500 mm H. 1180 mm 2 cartons W. 950 mm L. 2150 mm H. 110 mm
Packed weight	approx. 650 kg

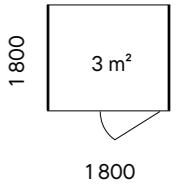

* 60mm less length near door frame

POWER

	EU / UK / CHINA	US
Input	220-240 VAC / 10 A	100-130 VAC / 15 A
Output	220-240 VAC / 9 A	100-130 VAC / 14 A
Frequency	50/60 Hz	50/60 Hz
Normal power consumption	34 W	34 W
Max. power consumption	39 W	39 W
LED power consumption	18 W	18 W
Normal Fan power consumption	16 W	16 W
Standby Fan power consumption	11 W	11 W
Max. Fan power consumption	21 W	21 W

Power supply	From roof or from floor with 5m power cable
Socket	1 x 4 pc power sockets
Light	1 x Dimmable LED light, Length 1,4 m, Lumens 2296 lm, color temperature 4000 k
Ventilation	Adjustable fan, Auto mode
Safety Switch	RCBO

WARRANTY

Elements / glass	5 years
Electric	2 years

SPRINKLER / CABLE HOLE

Safe modification area for small holes marked on roof.
See instructions before any modifications!

DOOR HANDEDNESS

Left or right handed option

EXTRA ACCESSORIES

- Clothes hook
- LB2 Sofa
- Screen Holder
- Extra sockets (power, USB, RJ45 CAT6)

COLOR OPTIONS

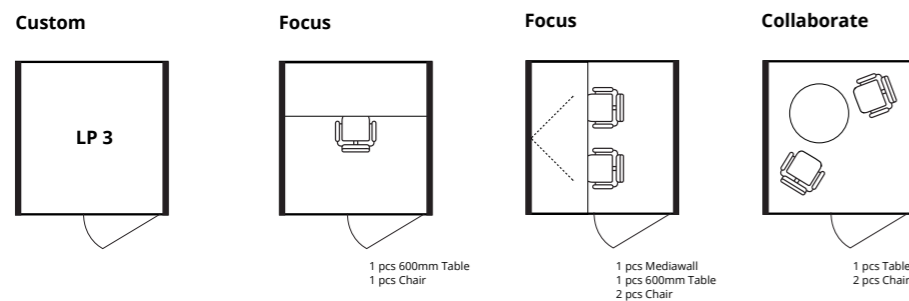
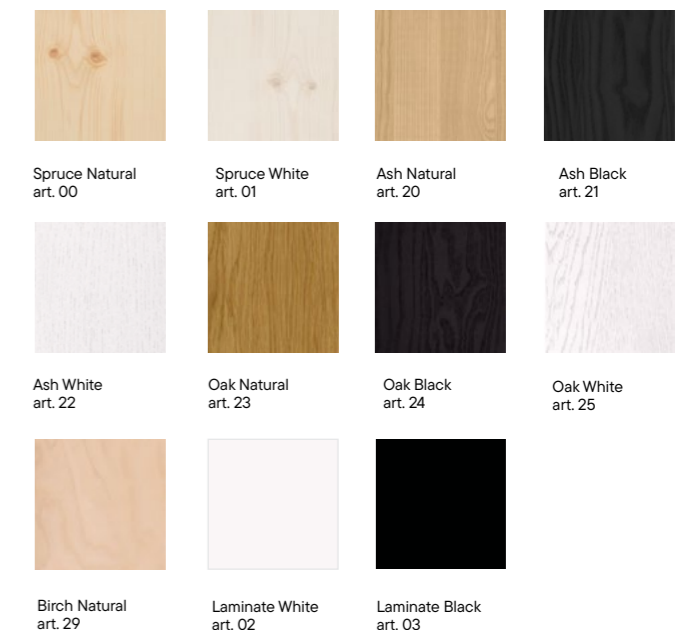

Lohko Picea³

Introducing the Lohko Picea 3, your ideal office pod designed for one or two individuals. This size is perfectly suited for a private, soundproof workstation, creating an optimal environment for focused work.



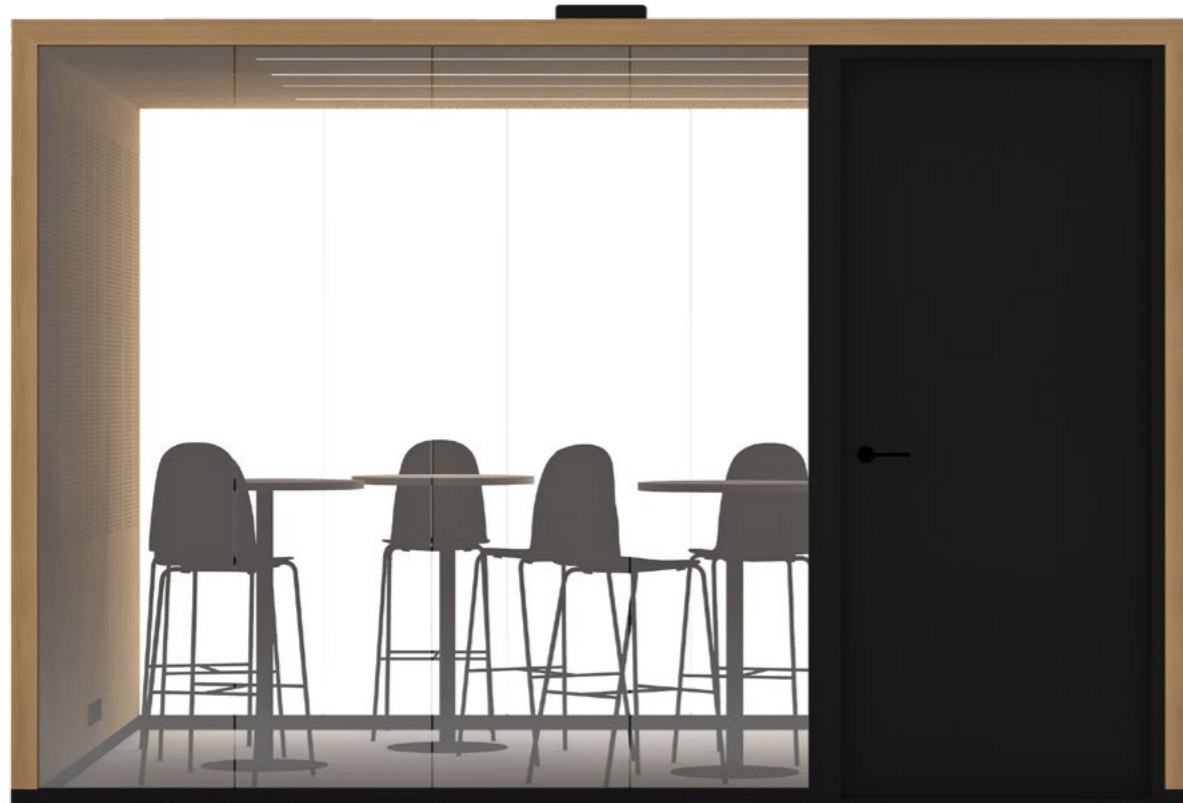

GENERAL DESCRIPTION

Product number	LF363000
Capacity	6-8 people
Ventilation	210 l/s

MATERIALS

Surface	Veneer or laminate
Walls structure	Wooden sandwich structure
Inside wall	Perforated surface
Glass	Laminated and tempered sound control glass
Door	Black RAL 9005, In project customizable. Opens inside

MEASUREMENTS

External dimensions	W. 3600 mm L. 3000 mm H. 2450 mm
Wall dimensions	W. 3600 mm L. 3000 mm H. 2400 mm
Internal dimensions	W. 3440 mm L. 2840 mm H. 2320 mm *
Recommended ceiling height	H. 2550 mm
Door opening width	W. 950 mm H. 2250 mm
Product weight	approx. 1400 kg
Product packages	2 pallet W. 750 mm L. 2500 mm H. 1160 mm
Packed weight	approx. 1590 kg

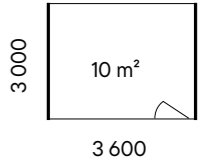

* 60mm less length near door frame

POWER

	EU / UK / CHINA	US
Input	220-240 VAC / 10 A	100-130 VAC / 15 A
Output	220-240 VAC / 9 A	100-130 VAC / 14 A
Frequency	50/60 Hz	50/60 Hz
Normal power consumption	162,4 W	162,4 W
Max. power consumption	177,4 W	177,4 W
LED power consumption	114,4 W	114,4 W
Normal Fan power consumption	48 W	48 W
Standby Fan power consumption	33 W	33 W
Max. Fan power consumption	63 W	63 W

Power supply: From roof or from floor with 10 m power cable
 Socket: 1 x 4 pc power sockets
 Light: 4 x Dimmable LED light, Length 2 m, Lumens 14432 lm, color temperature 4000 k
 Ventilation: Adjustable fan, Auto mode
 Safety Switch: RCBO

WARRANTY

Elements / glass	5 years
Electric	2 years

SPRINKLER / CABLE HOLE

Safe modification area for small holes marked on roof.
See instructions before any modifications!

DOOR HANDEDNESS

Right handed

EXTRA ACCESSORIES

- Clothes hook
- LB2 / LB3 Sofa
- Screen Holder
- Extra sockets (power, USB, RJ45 CAT6)

COLOR OPTIONS

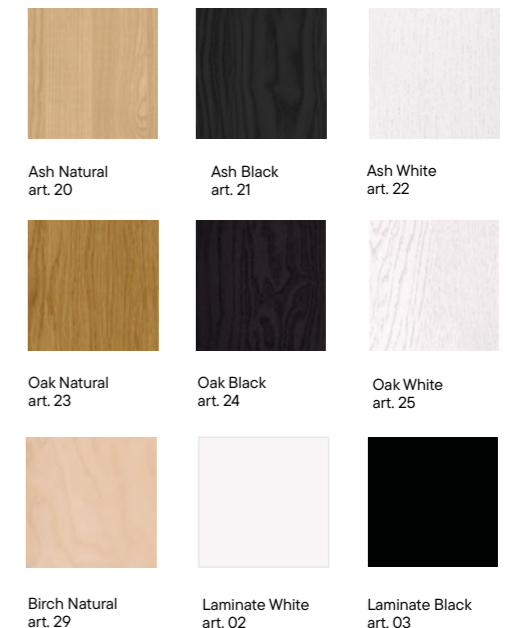

Lohko Flex¹⁰

Spacious meeting pod or a coworking booth for up to 8 people. Compact enough to fit most offices yet expansive enough to accommodate all needed technology.



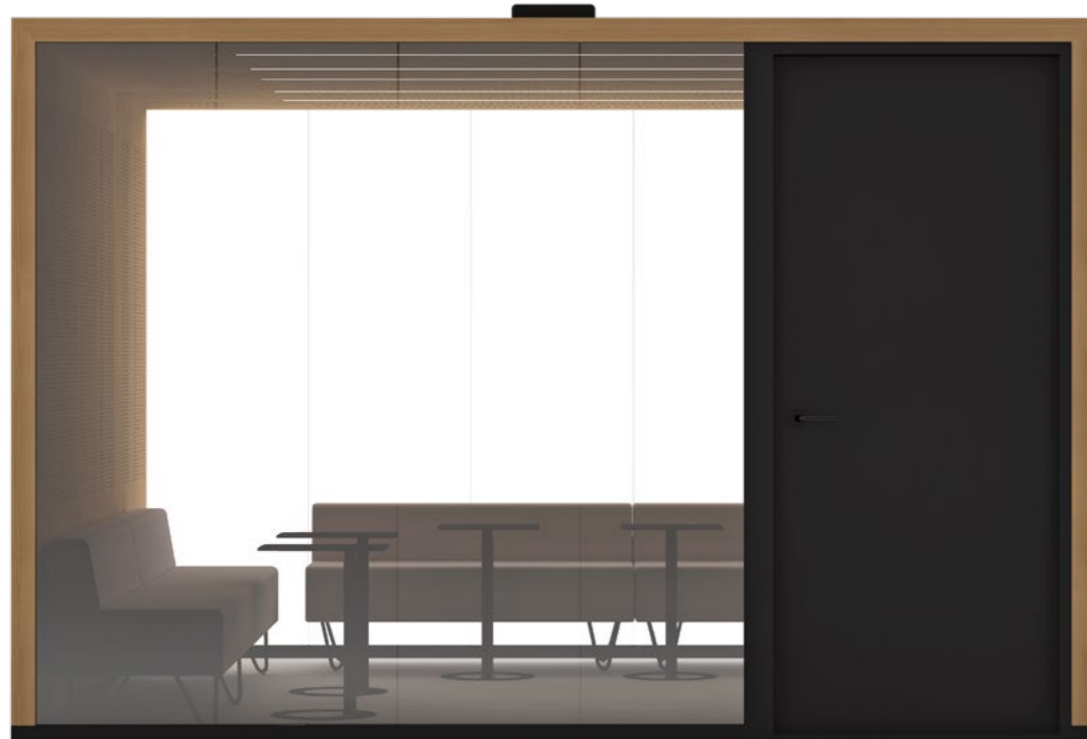

GENERAL DESCRIPTION

Product number	LF363600
Capacity	8-10 people
Ventilation	210 l/s

MATERIALS

Surface	Veneer or laminate
Walls structure	Wooden sandwich structure
Inside wall	Perforated surface
Glass	Laminated and tempered sound control glass
Door	Black RAL 9005, In project customizable. Opens inside

MEASUREMENTS

External dimensions	W. 3600 mm L. 3600 mm H. 2450 mm
Wall dimensions	W. 3600 mm L. 3600 mm H. 2400 mm
Internal dimensions	W. 3440 mm L. 3440 mm H. 2320 mm *
Recommended ceiling height	H. 2550 mm
Door opening width	W. 950 mm H. 2250 mm
Product weight	approx. 1590 kg
Product packages	3 pallet W. 750 mm L. 2500 mm H. 1160 mm
Packed weight	approx. 1890 kg

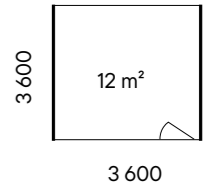

* 60mm less length near door frame

POWER

	EU / UK / CHINA	US
Input	220-240 VAC / 10 A	100-130 VAC / 15 A
Output	220-240 VAC / 9 A	100-130 VAC / 14 A
Frequency	50/60 Hz	50/60 Hz
Normal power consumption	191 W	191 W
Max. power consumption	206 W	206 W
LED power consumption	143 W	143 W
Normal Fan power consumption	48 W	48 W
Standby Fan power consumption	33 W	33 W
Max. Fan power consumption	63 W	63 W

Power supply	From roof or from floor with 10 m power cable
Socket	1 x 4 pc power sockets
Light	5 x Dimmable LED light, Length 2 m, Lumens 18040 lm, color temperature 4000 K
Ventilation	Adjustable fan, Auto mode
Safety Switch	RCBO

WARRANTY

Elements / glass	5 years
Electric	2 years

SPRINKLER / CABLE HOLE

Safe modification area for small holes marked on roof.
See instructions before any modifications!

DOOR HANDEDNESS

Right handed

EXTRA ACCESSORIES

Clothes hook
LB2 / LB3 Sofa
Screen Holder
Extra sockets (power, USB, RJ45 CAT6)

COLOR OPTIONS

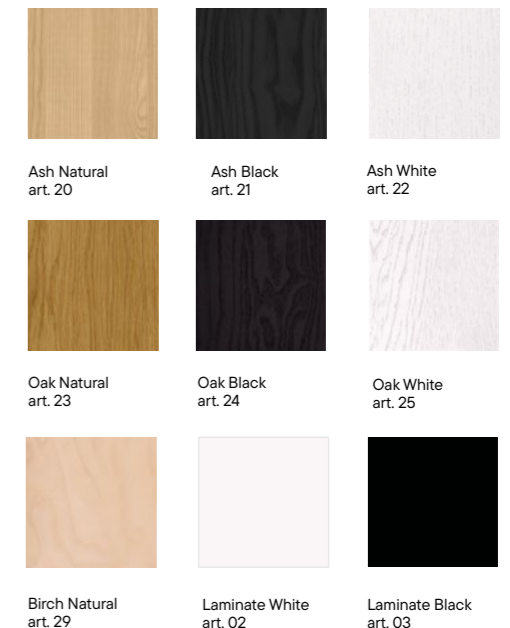

Lohko Flex¹²

Versatile 12 square meter office meeting booth for various purposes. Use it as a coworking booth, or transform it into a convenient waiting room for up to 10 people.



GENERAL DESCRIPTION

Product number	LF364200
Capacity	10-12 people
Ventilation	280 l/s

MATERIALS

Surface	Veneer or laminate
Walls structure	Wooden sandwich structure
Inside wall	Perforated surface
Glass	Laminated and tempered sound control glass
Door	Black RAL 9005, In project customizable. Opens inside

MEASUREMENTS

External dimensions	W. 3600 mm L. 4200 mm H. 2450 mm
Wall dimensions	W. 3600 mm L. 4200 mm H. 2400 mm
Internal dimensions	W. 3440 mm L. 4040 mm H. 2320 mm *
Recommended ceiling height	H. 2550 mm
Door opening width	W. 950 mm H. 2250 mm
Product weight	approx. 1770 kg
Product packages	3 pallet W. 750 mm L. 2500 mm H. 1160 mm
Packed weight	approx. 2070 kg

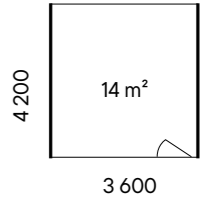

* 60mm less length near door frame

POWER

Input	220-240 VAC / 10 A
Output	220-240 VAC / 9 A
Frequency	50/60 Hz
Normal power consumption	235,6 W
Max. power consumption	255,6 W
LED power consumption	171,6 W
Normal Fan power consumption	64 W
Standby Fan power consumption	44 W
Max. Fan power consumption	84 W

EU / UK / CHINA

Input	220-240 VAC / 10 A
Output	220-240 VAC / 9 A
Frequency	50/60 Hz
Normal power consumption	235,6 W
Max. power consumption	255,6 W
LED power consumption	171,6 W
Normal Fan power consumption	64 W
Standby Fan power consumption	44 W
Max. Fan power consumption	84 W

US

Input	100-130 VAC / 15 A
Output	100-130 VAC / 14 A
Frequency	50/60 Hz
Normal power consumption	235,6 W
Max. power consumption	255,6 W
LED power consumption	171,6 W
Normal Fan power consumption	64 W
Standby Fan power consumption	44 W
Max. Fan power consumption	84 W

Power supply	From roof or from floor with 10 m power cable
Socket	1 x 4 pc power sockets
Light	6 x Dimmable LED light, Length 2 m, Lumens 21648 lm, color temperature 4000 k
Ventilation	Adjustable fan, Auto mode
Safety Switch	RCBO

WARRANTY

Elements / glass	5 years
Electric	2 years

SPRINKLER / CABLE HOLE

Safe modification area for small holes marked on roof.
See instructions before any modifications!

DOOR HANDEDNESS

Right handed

EXTRA ACCESSORIES

- Clothes hook
- LB2 / LB3 Sofa
- Screen Holder
- Extra sockets (power, USB, RJ45 CAT6)

COLOR OPTIONS

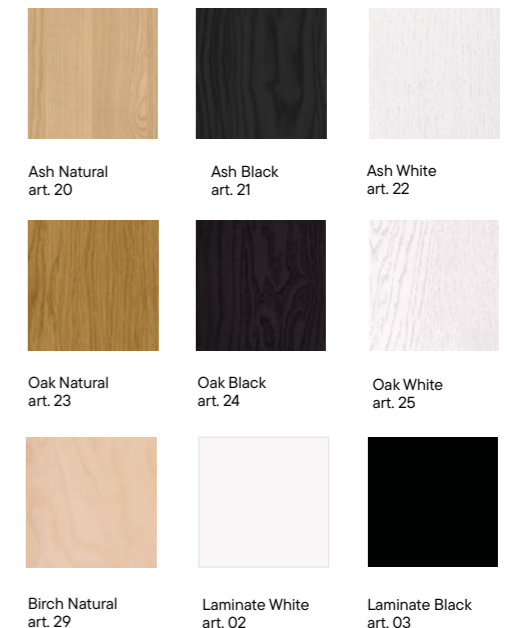

Lohko Flex¹⁴

Designed for larger offices, Lohko Flex 14 provides ample space for up to 12 individuals. A spacious conference room or a quiet co-working space within your office.





GENERAL DESCRIPTION

Product number	LF544200
Capacity	12-14 people
Ventilation	280 l/s

MATERIALS

Surface	Veneer or laminate
Walls structure	Wooden sandwich structure
Inside wall	Perforated surface
Glass	Laminated and tempered sound control glass
Door	Black RAL 9005, In project customizable. Opens inside

MEASUREMENTS

External dimensions	W. 5400 mm L. 4200 mm H. 2470 mm
Wall dimensions	W. 5400 mm L. 4200 mm H. 2400 mm
Internal dimensions	W. 5240 mm L. 4040 mm H. 2320 mm *
Recommended ceiling height	H. 2550 mm
Door opening width	W. 950 mm H. 2250 mm
Product weight	approx. 2290 kg
Product packages	3 pallet W. 750 mm L. 2500 mm H. 1160 mm
Packed weight	approx. 2660 kg

* 60mm less length near door frame

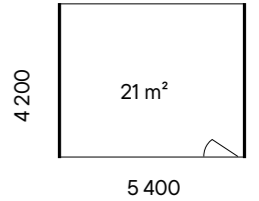

POWER

Input	220-240 VAC / 10 A
Output	220-240 VAC / 9 A
Frequency	50/60 Hz
Normal power consumption	235,6 W
Max. power consumption	255,6 W
LED power consumption	171,6 W
Normal Fan power consumption	64 W
Standby Fan power consumption	44 W
Max Fan power consumption	84 W

EU / UK / CHINA

Input	220-240 VAC / 10 A
Output	220-240 VAC / 9 A
Frequency	50/60 Hz
Normal power consumption	235,6 W
Max. power consumption	255,6 W
LED power consumption	171,6 W
Normal Fan power consumption	64 W
Standby Fan power consumption	44 W
Max Fan power consumption	84 W

US

Input	100-130 VAC / 15 A
Output	100-130 VAC / 14 A
Frequency	50/60 Hz
Normal power consumption	235,6 W
Max. power consumption	255,6 W
LED power consumption	171,6 W
Normal Fan power consumption	64 W
Standby Fan power consumption	44 W
Max Fan power consumption	84 W

Power supply	From roof or from floor with 10 m power cable
Socket	2 x 4 pc power sockets
Light	6 x Dimmable LED light, Length 2 m, Lumens 21648 lm, color temperature 4000 K
Ventilation	Adjustable fan, Auto mode
Safety Switch	RCBO

WARRANTY

Elements / glass	5 years
Electric	2 years

SPRINKLER / CABLE HOLE

Safe modification area for small holes marked on roof.
See instructions before any modifications!

DOOR HANDEDNESS

Right handed

EXTRA ACCESSORIES

- Clothes hook
- LB2 / LB3 Sofa
- Screen Holder
- Extra sockets (power, USB, RJ45 CAT6)

COLOR OPTIONS

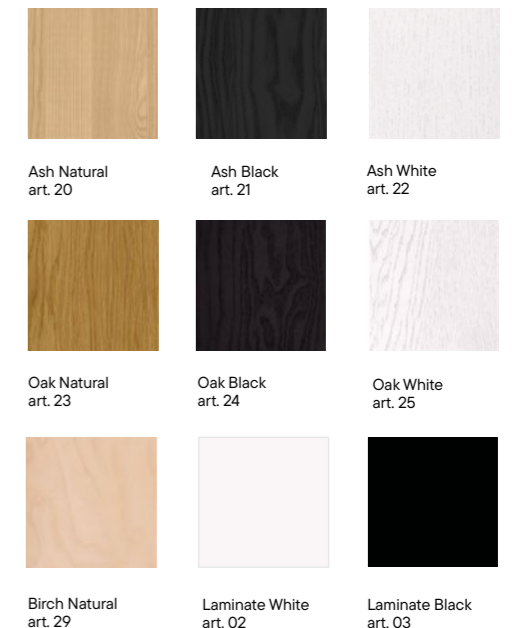

Lohko Flex²¹

Team-focused modular workspace that comfortably accommodates a full team of up to 14 people. It's the ideal choice for a conference room or a dynamic co-working space for larger teams.





GENERAL DESCRIPTION

Product number	LF544800
Capacity	14-16 people
Ventilation	280 l/s

MATERIALS

Surface	Veneer or laminate
Walls structure	Wooden sandwich structure
Inside wall	Perforated surface
Glass	Laminated and tempered sound control glass
Door	Black RAL 9005, In project customizable. Opens inside

MEASUREMENTS

External dimensions	W. 5400 mm L. 4800 mm H. 2470 mm
Wall dimensions	W. 5400 mm L. 4800 mm H. 2400 mm
Internal dimensions	W. 5240 mm L. 4640 mm H. 2320 mm *
Recommended ceiling height	H. 2550 mm
Door opening width	W. 950 mm H. 2250 mm
Product weight	approx. 2600 kg
Product packages	4 pallet W. 750 mm L. 2500 mm H. 1160 mm
Packed weight	approx. 3000 kg

* 60mm less length near door frame

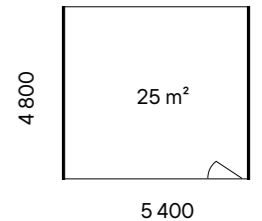

POWER

Input	220-240 VAC / 10 A
Output	220-240 VAC / 9 A
Frequency	50/60 Hz
Normal power consumption	264,2 W
Max. power consumption	284,2 W
LED power consumption	200,2 W
Normal Fan power consumption	64 W
Standby Fan power consumption	44 W
Max. Fan power consumption	84 W

EU / UK / CHINA

Input	220-240 VAC / 10 A
Output	220-240 VAC / 9 A
Frequency	50/60 Hz
Normal power consumption	264,2 W
Max. power consumption	284,2 W
LED power consumption	200,2 W
Normal Fan power consumption	64 W
Standby Fan power consumption	44 W
Max. Fan power consumption	84 W

US

Input	100-130 VAC / 15 A
Output	100-130 VAC / 14 A
Frequency	50/60 Hz
Normal power consumption	264,2 W
Max. power consumption	284,2 W
LED power consumption	200,2 W
Normal Fan power consumption	64 W
Standby Fan power consumption	44 W
Max. Fan power consumption	84 W

Power supply	From roof or from floor with 10 m power cable
Socket	2 x 4 pc power sockets
Light	7 x Dimmable LED light, Length 2 m, Lumens 25256 lm, color temperature 4000 K
Ventilation	Adjustable fan, Auto mode
Safety Switch	RCBO

WARRANTY

Elements / glass	5 years
Electric	2 years

SPRINKLER / CABLE HOLE

Safe modification area for small holes marked on roof.
See instructions before any modifications!

DOOR HANDEDNESS

Right handed

EXTRA ACCESSORIES

Clothes hook
LB2 / LB3 Sofa
Screen Holder
Extra sockets (power, USB, RJ45 CAT6)

COLOR OPTIONS

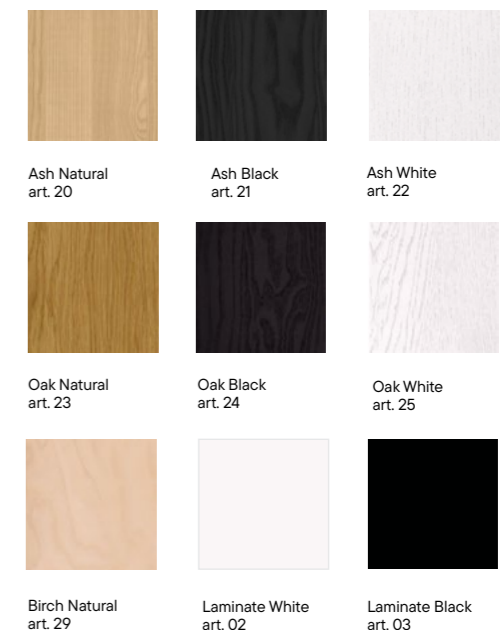

Lohko Flex²⁵

The second largest modular office booth of Taiga is a spacious meeting haven that can host up to 16 individuals with ease. A productive meeting booth or a spacious conference room with fresh air and extra comfort.





GENERAL DESCRIPTION

Product number	LF545400
Capacity	16-18 people
Ventilation	350 l/s

MATERIALS

Surface	Veneer or laminate
Walls structure	Wooden sandwich structure
Inside wall	Perforated surface
Glass	Laminated and tempered sound control glass
Door	Black RAL 9005, In project customizable. Opens inside

MEASUREMENTS

External dimensions	W. 5400 mm L. 5400 mm H. 2470 mm
Wall dimensions	W. 5400 mm L. 5400 mm H. 2400 mm
Internal dimensions	W. 5240 mm L. 5240 mm H. 2320 mm *
Recommended ceiling height	H. 2550 mm
Door opening width	W. 950 mm H. 2250 mm
Product weight	approx. 2835 kg
Product packages	5 pallet W. 750 mm L. 2500 mm H. 1160 mm
Packed weight	approx. 3325 kg

* 60mm less length near door frame

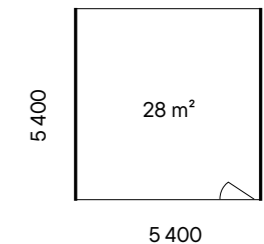

POWER

Input	220-240 VAC / 10 A
Output	220-240 VAC / 9 A
Frequency	50/60 Hz
Normal power consumption	308,8 W
Max. power consumption	333,8 W
LED power consumption	228,8 W
Normal Fan power consumption	80 W
Standby Fan power consumption	55 W
Max. Fan power consumption	105 W

EU / UK / CHINA

Input	220-240 VAC / 10 A
Output	220-240 VAC / 9 A
Frequency	50/60 Hz
Normal power consumption	308,8 W
Max. power consumption	333,8 W
LED power consumption	228,8 W
Normal Fan power consumption	80 W
Standby Fan power consumption	55 W
Max. Fan power consumption	105 W

US

Input	100-130 VAC / 15 A
Output	100-130 VAC / 14 A
Frequency	50/60 Hz
Normal power consumption	308,8 W
Max. power consumption	333,8 W
LED power consumption	228,8 W
Normal Fan power consumption	80 W
Standby Fan power consumption	55 W
Max. Fan power consumption	105 W

Power supply	From roof or from floor with 10 m power cable
Socket	2 x 4 pc power sockets
Light	8 x Dimmable LED light, Length 2 m, Lumens 28864 lm, color temperature 4000 k
Ventilation	Adjustable fan, Auto mode
Safety Switch	RCBO

WARRANTY

Elements / glass	5 years
Electric	2 years

SPRINKLER / CABLE HOLE

Safe modification area for small holes marked on roof.
See instructions before any modifications!

DOOR HANDEDNESS

Right handed

EXTRA ACCESSORIES

Clothes hook	
LB2 / LB3 Sofa	
Screen Holder	
Extra sockets (power, USB, RJ45 CAT6)	

COLOR OPTIONS

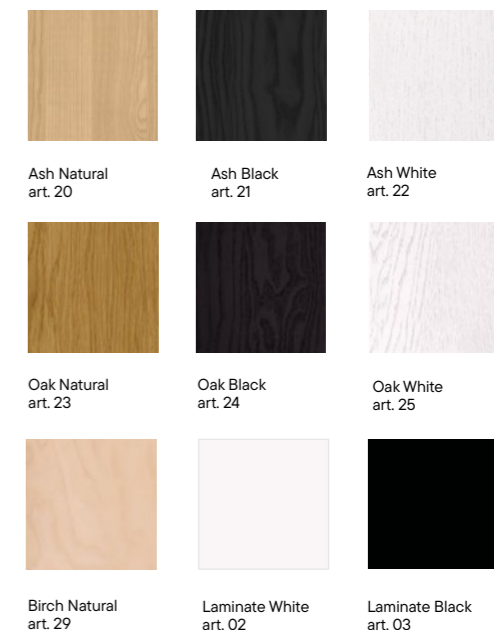

Lohko Flex²⁸

The largest in the Flex series, Lohko Flex 28 accommodates up to 18 people. Whether you need a peaceful office meeting booth, a welcoming waiting room, or an engaging game room, it will meet all the needs of a modern office.



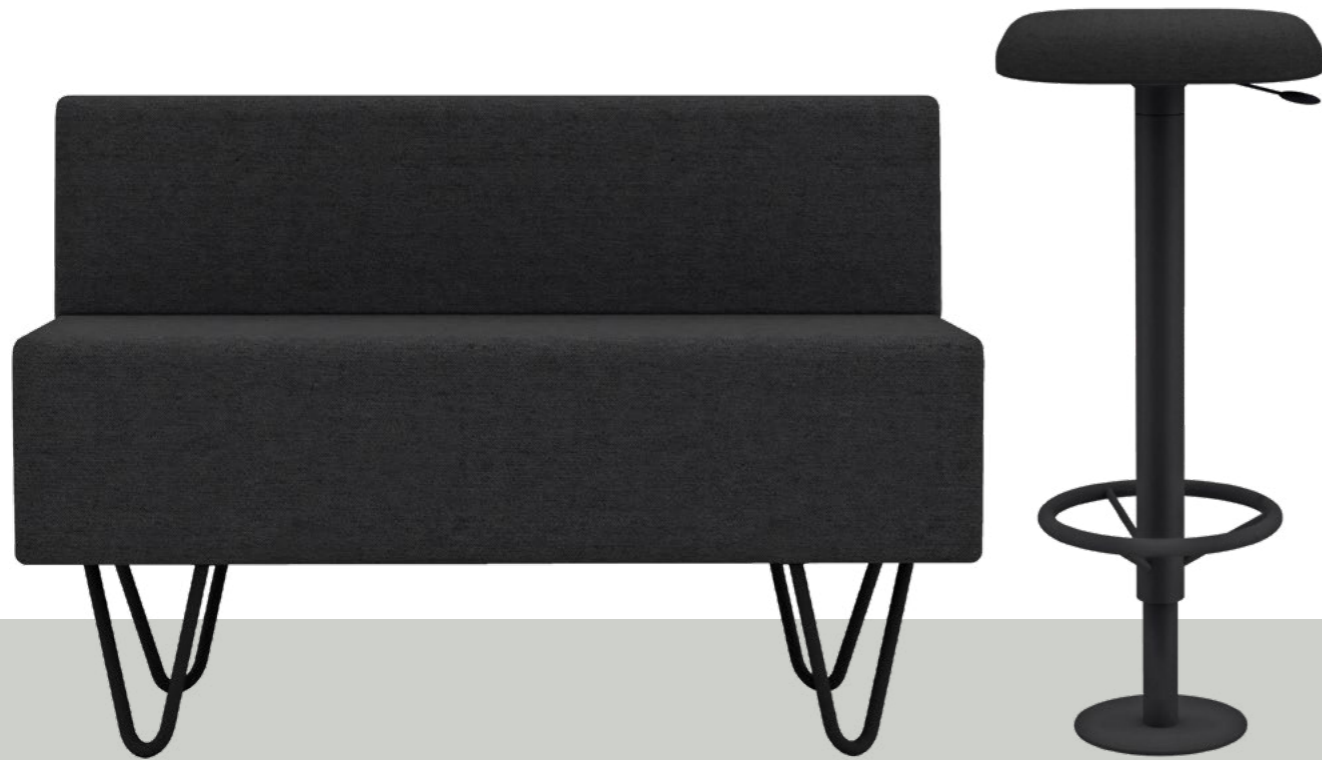

Lohko Seating

Lohko Seating encompasses an artfully crafted range of sofas and stools designed to enhance your workspace. At the heart of this collection lies Taiga's commitment to timeless design principles. The fusion of high-quality materials and thoughtful, ergonomic design ensures an optimal working experience for teams of all sizes.

Lohko Sofa²

Product number	LS0200
Dimensions	1020 mm x 650 mm x 710mm
Capacity	1-2 people
Weight approx.	25 kg

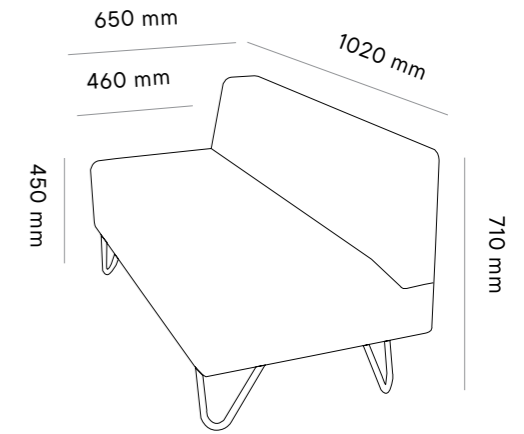

Lohko Sofa³

Product number	LS0300
Dimensions	1415 mm x 650 mm x 710mm
Capacity	1-3 people
Weight approx.	30 kg

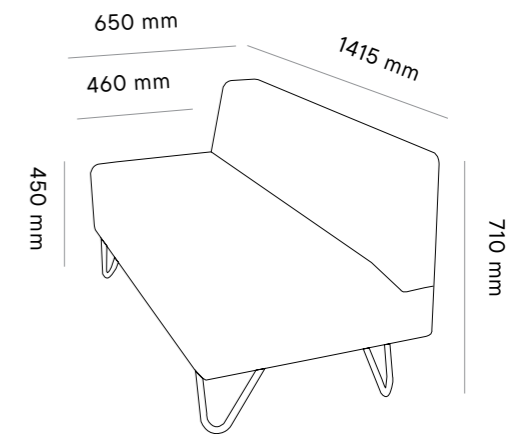

Lohko Stool

Product number	LS0101
Dimensions	350 mm x 350 mm x 810mm
Capacity	1 people
Weight approx.	10 kg

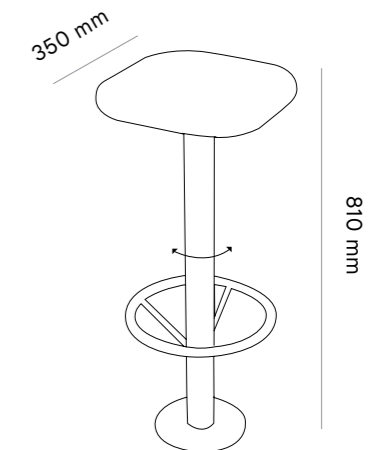

Lohko Triangle Table

Product number	LTA14565A
Dimensions	1450 mm x 750 mm x 650mm
Surface	Antibacterial black matt laminate
Legs	Black matt painted steel legs

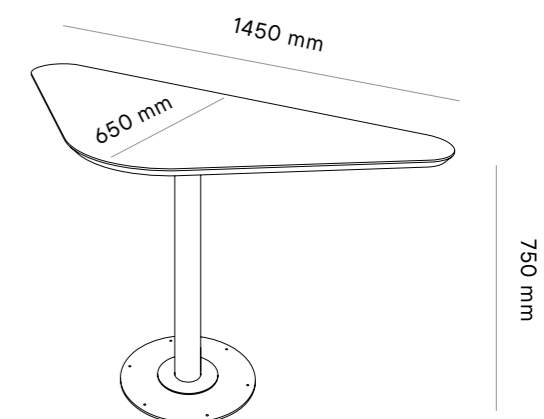



Lohko Tables

Lohko Tables are artfully crafted to optimally fit Taiga's workspaces. They feature a high-quality steel legs, and an elegant black laminate finish. Lohko Table ensures practicality across workspace configurations with a variety of different powering options to meet unique needs.

Lohko Table²

Product number	LTA09050
Dimensions	900 mm x 500 mm x 750mm
Surface	Antibacterial black matt laminate
Legs	Black matt painted steel legs
Power	2 x power socket

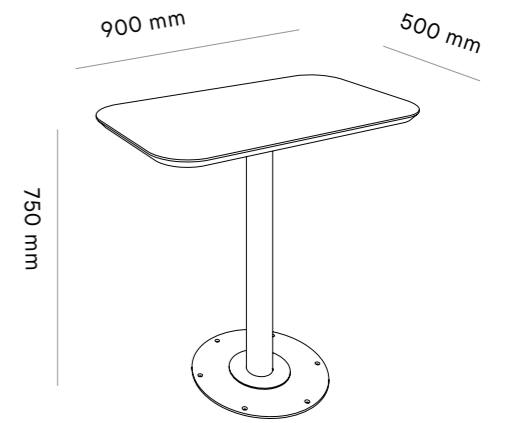

Lohko Table³

Product number	LTA09090
Dimensions	900 mm x 900 mm x 750 mm
Surface	Antibacterial black matt laminate
Legs	Black matt painted steel legs
Power	2 x power socket

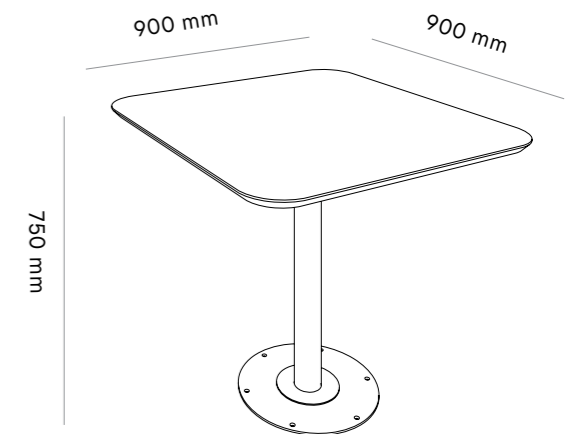

Lohko Table⁵

Product number	LTB14070
Dimensions	1400 mm x 700 mm x 650 - 1200 mm
Surface	Antibacterial black matt laminate
Legs	Adjustable Black matt painted steel legs
Power	2 x power socket

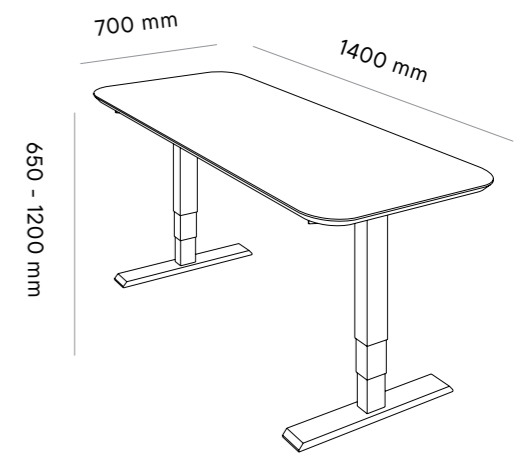

Lohko Table⁷

Product number	LTB22070
Dimensions	2200 mm x 700 mm x 650 - 1200 mm
Surface	Antibacterial black matt laminate
Legs	Adjustable Black matt painted steel legs
Power	2 x power socket

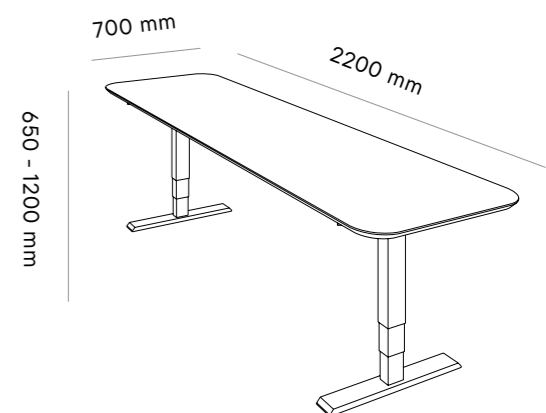

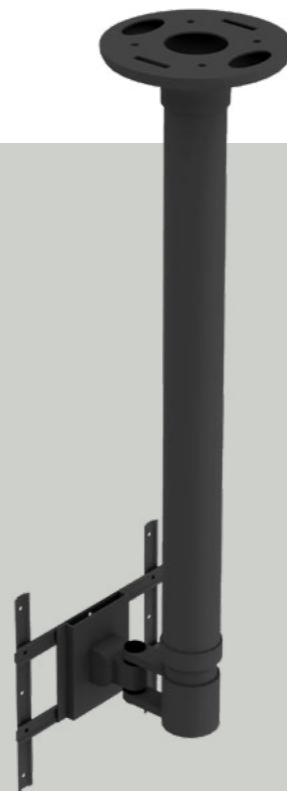
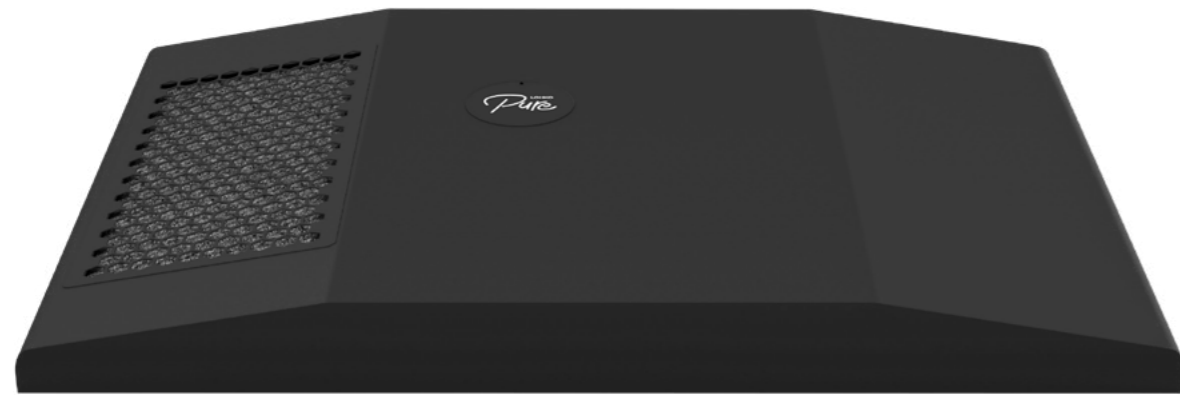

Lohko Pure

Lohko Pure uses advanced bipolar ionization technology. It contains both a filter and an ionization device that effectively destroys microbes in the air, reduces pathogens on surfaces and removes any odors.

Lohko Pure

Product number	PU0200
Filter	F7
Filter Technique	Bipolar ionisation
Compatible	LB2 / LB3 / LB5 / LB7, Lohko Flexes
Power consumption	50 W
Maintenance interval	2 year ionisation, 1 year filter
Min. ceiling height	Lohko Box 2450 mm, Lohko Flex 2650 mm

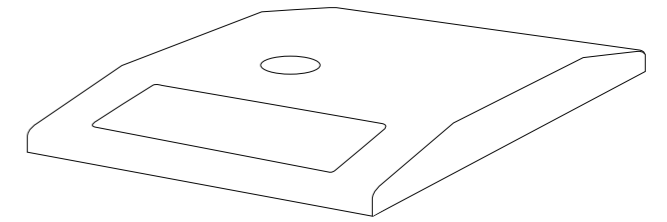

Lohko Pure Lite

Product number	PU0100
Filter	HEPA
Compatible	Lohko Boxes, Lohko Flexes
Maintenance interval	1 year filter
Min. ceiling height	Lohko Box 2450 mm, Lohko Flex 2650 mm

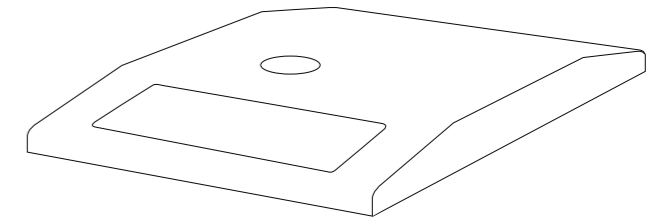

Screen Holder Table

Product number	ACCSH04
Capacity	32" screen

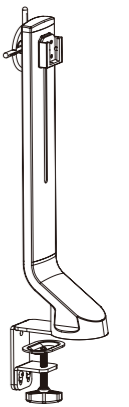

Screen Holder Roof

Dimensions	640-1040 mm x ø 60 mm
Product number	ACCSH03
Capacity	40" screen
Weight approx.	20 kg
VESA minimum	75 x 75 mm
Vesa maximum	200 x 200 mm

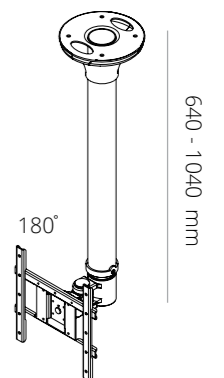



Sustainability

Taiga was born out of a desire to bring the quiet, calming, and restorative effects of Nordic nature into the workplace. That is why the environment has always been at the forefront of our minds. We design workspace solutions that last and can be reused and reassembled various times. Our supply chain choices reflect the nature-inspired, high-quality design of our products. This includes choosing responsibly sourced natural and renewable materials, resource-efficient manufacturing and sustained maintenance service. We work with partners that share our values, constantly reassess, and aim to find areas where resource efficiency and circularity can be improved.

Sound Isolation

In the past it was very difficult to compare sound isolating booths as there was no single recognised standard. The launch of the new ISO 23351-1 means that there is now such a clearly defined and regulated method to make it easier for customers to make their choice.











The new testing method produces a single figure named Speech Level Reduction which describes the level of speech privacy the booth provides. It has been ascertained that a speech level reduction of 30 dB is sufficient for practical sound insulation for a normal office environment. This in turn gives any product achieving that level an A-Class rating.

Upon testing our products to the new ISO standard, we achieved a rating of 29,5 dB, only 0,5 dB below the A-Class, which we believe can suffice for most office environments.





Learn more about our tests and certificates on our website.
www.taigaconcept.com

Color options - Veneer Surface







LOHKO FLEX without spruce surfaces

STANDARD							
	Ash Natural art. 20	Oak Natural art. 23	Oak Black art. 24	Birch Natural art. 29	Oak White art. 25	Spruce Natural art.00	Spruce White art. 01
PROJECT *							
	Ash Black art. 21	Ash White art. 22	Custom Project veneer				

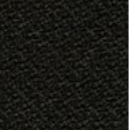
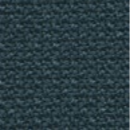
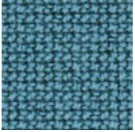
Color options - Laminate Surface

STANDARD								
	Matt White art.02 NCS - S 0500-N RAL - 9016	Matt Black art. 03 RAL - 9011 NCS - S 9000-N	Grey art. 04 NCS - S 5010-R90B	Green art. 05 RAL - 6018 NCS - S 2060-G30Y	Cinnabar art. 06 RAL - 2002 NCS - S 1080-Y80R	Turquoise art. 07 NCS - S 2050-B20G	Ultramarine art. 08 RAL - 5022 NCS - S 4550-R70B	Yellow art. 09 RAL - 1023 NCS - S 1070-Y10R
PROJECT *								
	Purple art. 10 RAL - 4006 NCS - S 3050-R30B	Brown art.11 RAL - 8007, 8025 NCS - S 6020-Y30R	Ocean green art. 12 NCS - S 3030-B70G	Green Khaki art. 13 NCS - S 3010-G20Y	Desert Sand art. 14 NCS - S 3020-Y20R	Ice Blue art. 15 NCS - S 1502-B	Sky Blue art. 16 NCS - S 3020-R90B	Custom Project colors

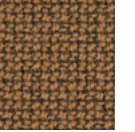
Color options - Acoustic panels & sofas

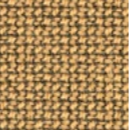
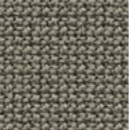
STANDARD								
	Gabriel Cura 60999	Gabriel Cura 66170	Gabriel Cura 66240	Gabriel Cura 68261	Gabriel Cura 62126	Gabriel Cura 61232	Gabriel Cura 61260	Gabriel Cura 62082
								
	Gabriel Cura 61233	Gabriel Cura 60110						

* PROJECT

Project surfaces might impact the price and delivery time. For more information contact Taiga Concept sales.

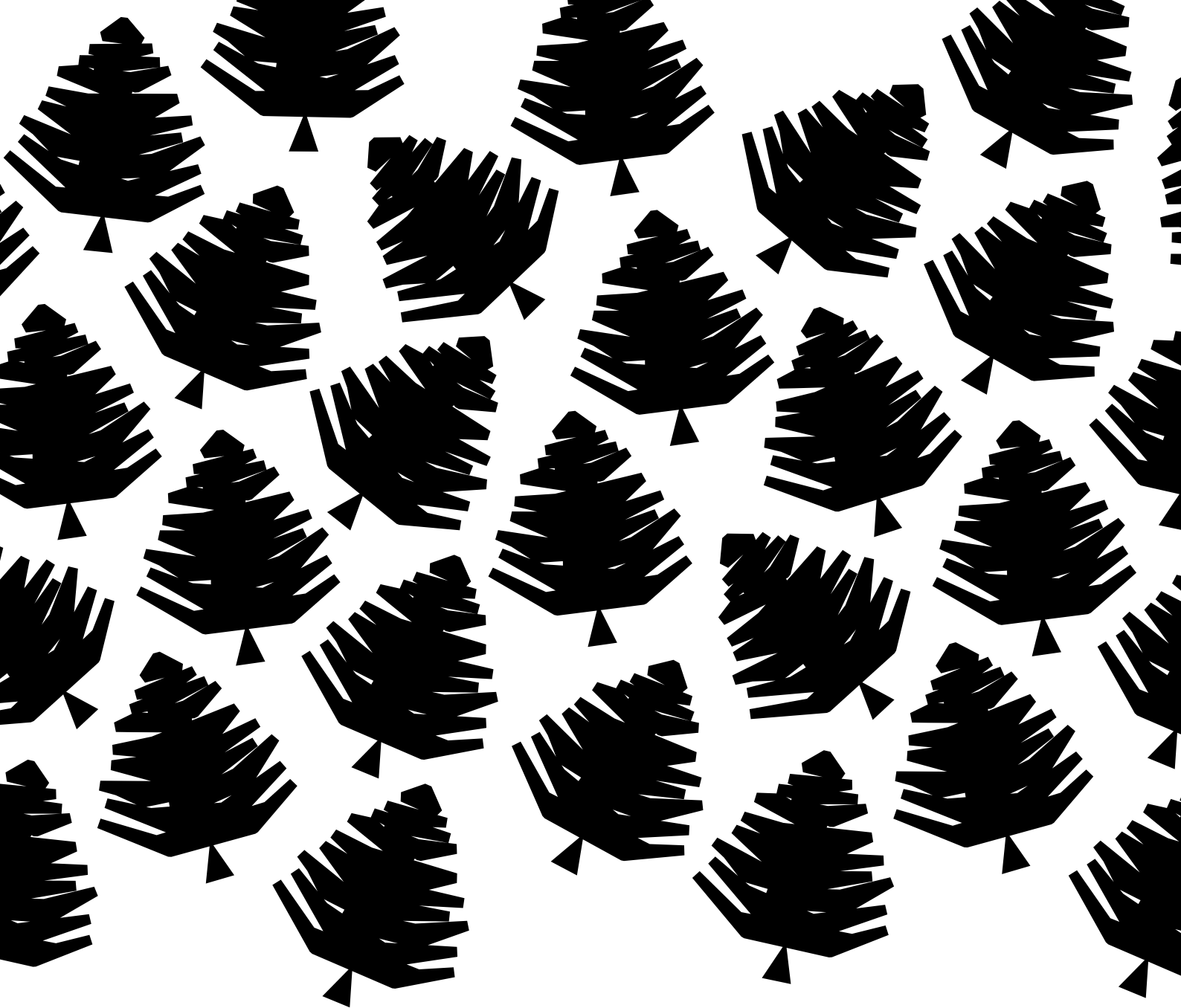

Your
natural
workspace

www.taigaconcept.com